



Owner's Manual
Models: 02117/60694/02678

READ & SAVE these instructions Carefully read and review before attempting to assemble, install, operate, or maintain this product. Observe all safety instructions and information. **FAILURE TO FOLLOW WARNINGS AND OPERATIONAL INSTRUCTIONS CONTAINED IN THIS MANUAL CAN RESULT IN SEVERE PROPERTY DAMAGE AND OR PERSONAL INJURY.**

*****For Residential Use Only*****

*****Important Notice*****

**Do not return to place of purchase!!
Please contact our Toll Free Hotline at
1-866-985-7877 for customer
service and warranty issues.**

SAVE THESE INSTRUCTIONS

Distributed by:
Well Traveled Living
Amelia Island, FL 32034
Web: www.wtliving.com
Email: cservice@welltraveled.net



Safety Guidelines

Read this manual carefully to become knowledgeable about your heater and how to use it properly.
To help recognize this information, observe the following symbols.

DANGER

Indicates a potentially hazardous situation which, if not avoided, WILL result in serious injury or death.

WARNING

Indicates a potentially hazardous situation, if not avoided, COULD result in serious injury or death.

CAUTION

Indicates a potentially hazardous situation which, if not avoided, MAY cause moderate injury or damage to the equipment.

NOTICE:

Indicates important information that if not followed, may cause damage to the equipment.

DANGER

1



Risk of Fire. There is always a risk of fire when working with a heater. Keep it away from flammable liquids and any material that could easily catch fire.

2.



Risk of Fire. If the heater falls, this unit might start a fire.

3.



Hot or Burn Hazard. This unit may be hot at any time during its use especially around the head and heating element.

4.



Electrical Hazard. Disconnect all electric power before working on the unit. There is a chance of electric shock if you work on this unit with it still plugged into the wall.

5.



Electric Shock. This unit uses electricity to operate. Do not use this heater around water or if the cord has been damaged.

CAUTION

- Improper treatment of the heater can damage it and also shorten its life span.
- To prevent electrical shock follow electrical plug requirements on page 9 of this manual.



This appliance **MUST** be grounded.

- * When using outdoors, we recommend using a certified GFI (Ground Fault Interrupt) outlet to protect against electrical shock.
- * All installations must be in accordance with I.E.E. safety regulations or the equivalent.
- * Avoid the use of an extension cord with this appliance.
- * Do not place any objects such as furniture, papers, clothing or curtains closer than 3 feet to the front and sides of the heater.

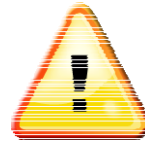

CAUTION!

PARTS LIST

1- IR Head unit w/Protective Shield with:

- * Pre-installed Tilt Switch (safety cut off)
- * On/Off Switch (PULL for ON, PUSH for OFF)
- * Angle Adjustment Bar
- * 1500 Watt quartz halogen bulb
- * Swivel Bracket
- * 12 foot, 16/3 grounded electrical cord



2 – Mounting Bracket – attaches head unit to telescopic pole

3 – Curved Upper Arm

4 – Inner support tube section for telescopic body

5 – Telescopic Body – adjustable

6 – Base connection pole section

7 – Support Collar w/Flange for Telescopic Body

8 – Base Assembly w/wheels

9 – Protective vinyl cover for head unit

10 – Hardware packet—19 threaded bolts;

2 small threaded screws w/flat washers;

1 – 3/4" nut w/flat washer and lock washer .



8



9



Important Instructions

1. Read all instructions before using this heater.
2. This heater is hot when in use. To avoid burns, do not let bare skin touch hot surfaces. Keep combustible materials, such as furniture, pillows, bedding, papers cloths, and curtains at least 3 feet (0.9m) from the front, sides and rear of the heater.
3. **DO NOT** leave heater unattended. Extreme caution is necessary when any heater is used by, or near, children or disabled persons, and whenever the heater is left operating and unattended.
4. Always unplug heater when not in use.
5. Do not operate any heater with a damaged cord or plug, if the heater malfunctions, or has been dropped or damaged in any manner. Return heater to authorized service facility for repair.
6. Can be used indoors or outdoors. Operate 3 feet (0.9m) from people or objects.
7. Never operate heater near water or where it can be knocked over.
8. Do not run cord under carpeting. Do not cover cord with throw rugs, runners, or similar coverings. Arrange cord away from traffic area **and where it will not be tripped over.**
9. To disconnect heater, switch to OFF position (push in switch located on head unit) and then remove plug from electrical outlet.
10. Connect to properly grounded outlets only.
11. Do not insert or allow foreign objects to enter any ventilation or exhaust opening; doing so may cause an electrical shock or fire, or may damage the heater.
12. To prevent a possible fire, do not block air intakes or exhaust in any manner. Do not use on soft surfaces, like a bed, where openings may become blocked.
13. A heater has hot and sparking parts inside. Do not use it in areas where gasoline, paint, or flammable liquids are used or stored.
14. Use this heater only as described in this manual. Any other use not recommended by the manufacturer may cause fire, electrical shock, or injury to persons.
15. Avoid the use of an extension cord because the extension cord may overheat and cause a risk of fire. However, if you must use an extension cord, use either a 12 gauge or 14 gauge wire which is rated not less than 1900 watts. The recommended length for a 14 gauge is 0-50 feet but if you must use a longer cord, use a 12 gauge **NO LONGER** than 100 feet.
16. This unit comes equipped with a Safety Tilt Switch mechanism. Power will shut off automatically should the unit be accidentally knocked over or tilted past 15 degrees. To reset, unplug the unit from wall outlet, reposition on a flat, level surface and plug in again.
17. **SAVE THESE INSTRUCTIONS** for future reference.

Assembling Your Heater

Before beginning assembly, be sure to read and familiarize yourself with the overall assembly process and instructions in this manual. It may be helpful to have someone assist you with the assembly. You will need the following tools (NOT INCLUDED):

- ** #2 or #3 Philips Screwdriver (or standard slotted screwdriver)
- ** Adjustable Wrench.

Make sure you complete assembly on a clean, level, preferably carpeted location. A flat piece of cardboard will also work for assembly. Unpack and identify all components listed on page 3 of this manual and lay them out on the carpeted floor or piece of cardboard and then follow the steps below:

STEP 1

Loosen and remove the top 2 screws on each side of the head unit (Part 1) and attach the angle adjustment handle (included with Part 1) as shown in Figure 1.

FIGURE 1



Tighten the screws as shown in Figure 2.

FIGURE 2



STEP 2

Using mounting bracket (Part 2), thread entire electrical cord through the mounting bracket as shown in Figure 3.

FIGURE 3

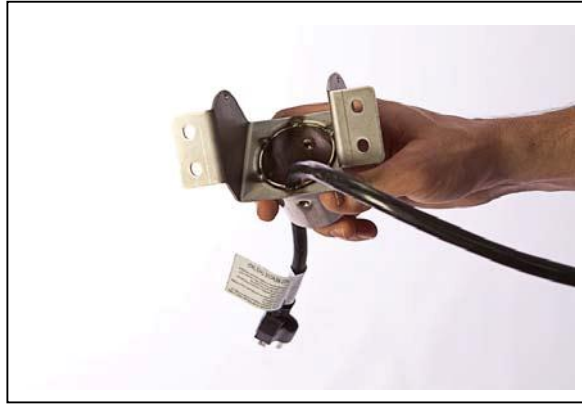

STEP 3

Using 4 threaded bolts, attach mounting bracket (Part 2) to head unit (Part 1) as shown in Figure 4.

FIGURE 4

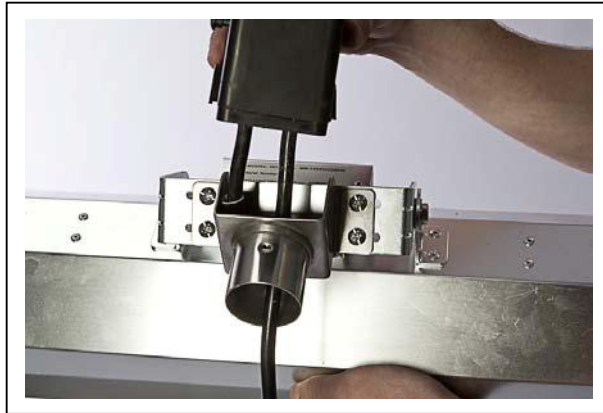

STEP 4

Align tilt switch (black box on head unit, Part 1) to threaded holes on mounting bracket (Part 2) and insert small screws with flat washers as shown in Figure 5.

FIGURE 5

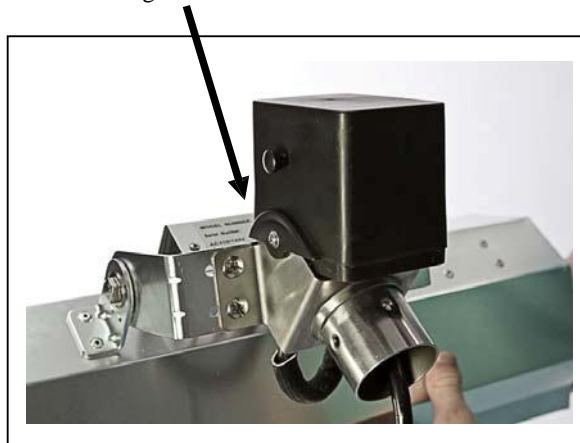

STEP 5

Thread electrical cord through curved upper arm (Part 3) and attach with 4 threaded bolts as shown in Figure 6.

FIGURE 6



STEP 6

Insert inner support tube (Part 4) inside telescopic body (Part 5) as shown in Figure 7. Tighten clamp collar as shown in Figure 8.

FIGURE 7



FIGURE 8



STEP 7

Thread electrical cord through inner support tube and telescopic body as shown in Figure 9 and affix curved upper arm and inner support tube with one threaded bolt as shown in Figure 10.

FIGURE 9



FIGURE 10



STEP 8

Thread electrical cord through base connection pole section (Part 6) and insert 4 threaded bolts as shown in Figure 11, 12 and 13.

FIGURE 11



FIGURE 12



FIGURE 13



STEP 9

Mount support collar flange (Part 7) to base assembly with wheels (Part 8) as shown in Figure 14, and secure with flat washer, lock washer, and 3/4" bolt as shown in Figure 15.

FIGURE 14



FIGURE 15



STEP 10

Carefully lift pole and head unit assembly and insert lower end of pole into support collar flange (Part 7) as shown in Figure 16. Secure with 6 threaded bolts.

FIGURE 16



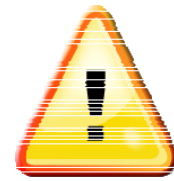

CAUTION!

OPERATING INSTRUCTIONS

This appliance **MUST** be grounded.

- * When using outdoors, we recommend using a certified GFI (Ground Fault Interrupt) outlet to protect against electrical shock.
- * **ALL** installations must be in accordance with I.E.E. safety regulations or equivalent.
- * Avoid the use of an extension cord with this appliance. If one is used, it must meet the requirements as outlined in #15, "Important Instructions" on page 4 of this manual.
- * Do not place any objects such as furniture, papers, clothing, or curtains closer than 3 feet to the front, top or sides of this heater.
- * **ALWAYS** unplug the heater when it is not in use.

For optimal performance and safety concerns, we **HIGHLY** recommend that the Infrared Heating System be operated at a minimum of 98" in height or the maximum extended length of the telescopic body sections. You should only lower the height of the unit for storage purposes when it has completely cooled and is not in operation.

To adjust the IR telescopic body:

Pull up on the release levers of the tightening clamps and adjust tension using the tension knobs. Raise and lower the telescopic sections and/or swivel to desired position and then push in clamp levers to secure. **DO NOT** over tighten tension knobs. There should only be a moderate amount of tension to maintain the telescopic position of your heater.



Lever clamps
and adjustment
knobs

Step 1

Before turning on your Infrared Heating System, check to make sure the "On/Off" switch located on the tilt switch (black box) of the head unit is pulled **OUT** or in the **ON** position (note: to turn the heater "Off", push in the switch). Next, extend all 3 telescopic sections to their maximum extended length. Release clamp levers and pull up on each of the sectional steel tubes until each tube stops. Then push in clamp levers to secure sections in place. Adjust the tension knobs as needed to maintain height position.

Step 2

The Infrared Heating System comes equipped with a heavy duty, 16/3 gauge wire and grounded plug. This appliance must be used with an outlet that has been installed and grounded in accordance with local codes and ordinances. Make sure the heater is connected to an outlet having the same configuration as shown in the figure shown to the right. **DO NOT** use an adapter with this product. Check with a licensed electrician if the grounding instructions are not understood completely or if the wall outlet does not match the plug.

Grounded outlet
box cover

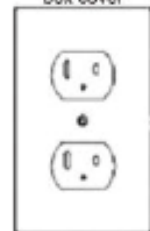

Step 3

Your Mojave Sun, Infrared Heating System is ready to enjoy. Plug the appliance in and enjoy the warmth!

Specifications

Model:	02117/60694/02678
Voltage:	120 volts
Amps:	12.5 amps
Wattage:	1500 watts
Lamp Type:	Quartz Halogen
Minimum Operational Height:	8 ft., 2 in. (98 in.)
Assembled Weight:	53 lbs.
Head Unit Dimensions:	4.5" x 7" x 22"
Heater Assembled Dimensions:	22" diameter base, 98" height

Storage

* **Always UNPLUG the unit when not in use.**

* Once the head unit has completely cooled, store the heater with the protective vinyl cover on the head unit.

* When heater is not in use for an extended period of time, store in a covered location that is dry and out of the weather. Make sure the heater is stored in a location that is out of the way of people and pets that may accidentally knock the heater over or damage the appliance. Before storing the heater, make sure the electrical cord is coiled and out of the way.

* When storing, **ALWAYS** lower the telescopic pole to its lowest level. This will make it easier to store and reduce the risk of any accidental tipping over of the heater.

Maintenance

Your Infrared Heating System is virtually maintenance free! A minute to wipe down exposed surfaces is all it takes to maintain your heater.

* Head unit and shield: Use a non-abrasive cleaner and a soft cloth to wipe off debris and dirt from the exposed surfaces. **NEVER spray liquids or cleaners into the housing area where the halogen lamp is located.** Do not try to disassemble or clean the inner cavity where the halogen lamp is located. For any maintenance on the head unit, please call the toll free customer service hotline.

* Telescopic pole and curved arm components: These can easily be wiped clean using a non-abrasive cleaner and a soft cloth.

* Base with wheel assembly: Use non-abrasive cleaner and a soft cloth. Any scratches, chips or rust spots can be touched up using an exterior matte finish black paint.

Halogen Lamp Replacement

Contact the toll free customer hotline to order approved replacement lamps and parts. Use **ONLY** approved original equipment and replacement halogen lamps to ensure safe, proper and maximum output operation of your heater. **NOTE:** Do **NOT** touch the new halogen lamp with your bare fingers. Oils from your hand could reduce the life of the lamp by causing a heat spot. We recommend using clean cotton or plastic gloves to handle the lamp. A clean paper towel will also work.

MAKE SURE THE HEATER IS TURNED OFF AND DISCONNECTED FROM THE ELECTRICAL OUTLET BEFORE YOU BEGIN!!!!

TO REPLACE THE HALOGEN LAMP:

1. Be sure the heater is unplugged from the wall outlet. Remove the head unit assembly from the telescopic pole.
2. Remove 8 screws from each end of the head unit and pull off end plates (#2). Note the placement of the 2 small sheet metal screws on each end plate. Also note end plate side with beveled holes faces outward when re-assembled.
3. Pull out and remove the left and right front air vent panels and protective wire grill (#3). Note the position of end clips on vent panel. They must be aligned as close to the end connectors of lamp tube as possible when re-assembled. Pull or push into place as needed. **DO NOT allow metal parts to touch the actual lamp tube when re-assembled.**
4. Gently pull out entire old lamp assembly from the clips at the terminal connection ends (#4 & 5). Slide and lift the connection ends out from the friction clips by gently pushing apart the clips. Unscrew wire leads from terminal. Remove entire old lamp assembly.
5. Using gloves, gently re-insert connection ends of the NEW lamp assembly into the friction clips (#4). Pull apart the clips slightly and gently push the connectors into place. Do not allow the metal clips to touch the lamp tube. The clips should be about at the center point of the end connectors.
6. Re-install the safety grill (fits along grooves in housing body), then re-insert the vent panels by gently pushing the end clips into housing body. Align clip ends close to the lamp end connectors and push into place. Re-attach end plates making sure the side with beveled holes faces out.

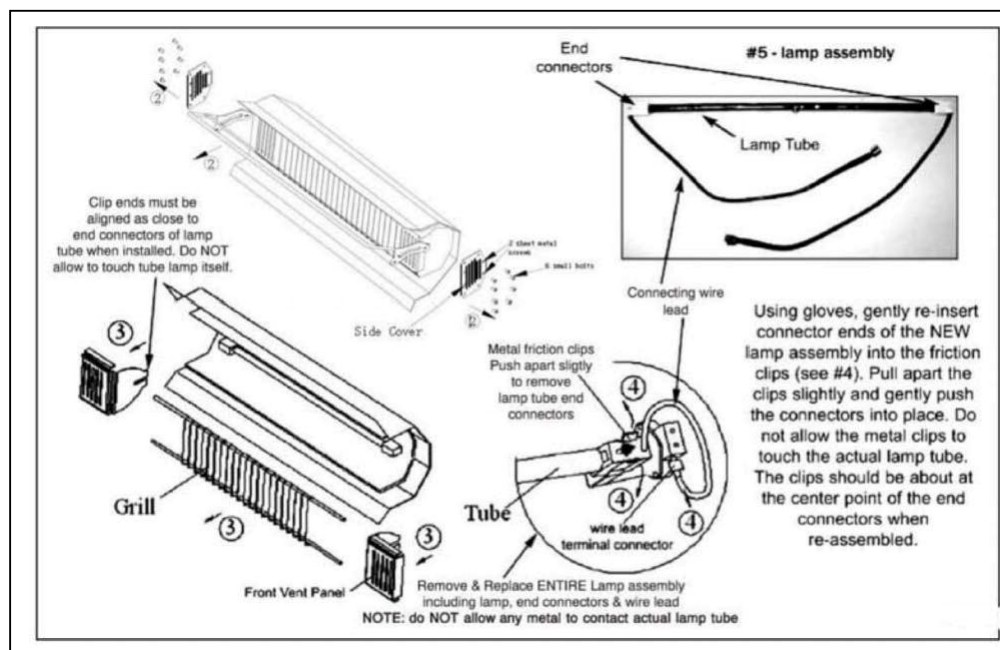

Troubleshooting

Problem	Solution
Unit fails to turn on.	<p>Check electrical plug connection at wall outlet for a complete, snug fit.</p> <p>Check to make sure the “On/Off” switch located on tilt switch is pulled OUT or in the “On” position.</p> <p>Check GFI and reset circuit breaker if needed.</p> <p>If unit is plugged into a wall outlet wired to an On/Off switch, make sure switch is in On Position.</p> <p>Reset safety tilt switch. Unplug unit from wall outlet and re-position on flat, level surface. Plug heater back into outlet.</p> <p>Damaged halogen bulb. Call customer service hotline.</p>
Telescopic pole slips down.	Tighten black tension knobs on clamp collars.
Telescopic pole is unsteady.	Tighten screws on support collar at base.
Telescopic pole will not adjust.	Electrical cord may be kinked. Gently pull end of cord until taut.
Head unit is loose or unsteady.	Tighten screws on curved upper arm mounting bracket.
Head unit is hard to adjust.	Loosen connecting bolts/nuts at adjustment bracket.
Smoke appears from head unit.	Unplug IMMEDIATELY and call customer service hotline.
Weak output from halogen lamp.	<p>Life span of lamp has been reached or damaged lamp. Call customer service hotline for assistance.</p> <p>NOTE: This product comes with a limited one year warranty. After the warranty period, you may purchase replacement bulbs from www.patiomarket.com at the lowest cost available.</p>

Distributed By:
Well Traveled Living
716 S 8th Street
Amelia Island, FL 32034
Toll Free: 866-WTL-SUPP



1 YEAR LIMITED WARRANTY – Customers in the Continental US

All components are warranted for a period of 1 year after date of purchase by the original owner against defects in materials and workmanship under normal use. This warranty does NOT cover normal wear and weathering, assembly and/or maintenance OR use in a commercial application. At Well Traveled Living's sole discretion, products under warranty will be repaired and/or replaced at no charge to the customer. Any returns sent back to Well Traveled Living must be sent via prepaid freight and in the original retail packaging.

For warranty service contact Well Traveled Living at the address, phone numbers or internet site and email listed in this owner's manual. Be sure to have your sales receipt, date of purchase and catalogue/model numbers available when calling. All warranty service will be coordinated by the Well Traveled Living's, Amelia Island, Florida service center.

This warranty is extended only to the original purchaser. Proof of purchase will be required before warranty service is rendered. The sales receipt is the only valid proof of purchase. This warranty only covers failures due to defects in materials or workmanship which occur during normal use. Failures and/or damage which result from accident, negligence, misuse, abuse, neglect, mishandling, alteration or modification, failure to maintain, improper assembly or maintenance, service by unauthorized agency or use of unauthorized components or damage that is attributable to acts of God are NOT covered.

*****THERE ARE NO EXPRESS WARRANTIES EXCEPT AS LISTED ABOVE*****

*****PURCHASER ASSUMES ALL RISKS IN THE ASSEMBLY AND OPERATION OF THIS UNIT*****

*****FAILURE TO FOLLOW WARNINGS AND OPERATIONAL INSTRUCTIONS CONTAINED IN THIS MANUAL CAN RESULT IN SEVERE PROPERTY DAMAGE AND/OR PERSONAL INJURY*****

IN NO EVENT WILL WELL TRAVELED LIVING, OR ITS DIRECTORS, OFFICERS OR AGENTS BE LIABLE TO THE PURCHASER OR ANY THIRD PARTY, WHETHER IN CONTRACT, IN TORT, OR ON ANY OTHER BASIS, FOR ANY INDIRECT, SPECIAL, PUNITIVE, EXEMPLARY, CONSEQUENTIAL, OR INCIDENTAL LOSS, COST, OR DAMAGE ARISING OUT OF OR IN CONNECTION WITH THE SALE, MAINTENANCE, USE, OR INABILITY TO USE THE PRODUCT, EVEN IF WELL TRAVELED LIVING OR ITS DIRECTORS, OFFICERS OR AGENTS HAVE BEEN ADVISED OF THE POSSIBILITY OF SUCH LOSSES, COSTS OR DAMAGES, OR IF SUCH LOSSES, COSTS, OR DAMAGES ARE FORESEEABLE. IN NO EVENT WILL WELL TRAVELED LIVING, OR ITS OFFICERS, DIRECTORS, OR AGENTS BE LIABLE FOR ANY DIRECT LOSSES, COSTS OR DAMAGES THAT EXCEED THE PURCHASE PRICE OF THE PRODUCT.

SOME JURISDICTIONS DO NOT ALLOW THE EXCLUSION OR LIMITATION OF INCIDENTAL OR CONSEQUENTIAL DAMAGES, SO THE ABOVE LIMITATION OR EXCLUSION MAY NOT APPLY TO THE PURCHASER.

This limited warranty gives you specific legal rights and you may also have other rights which vary from jurisdiction to jurisdiction. The provisions of the United Nations Convention on Contracts for the Sales of Goods shall not apply to this limited warranty or the sale of products covered by this limited warranty.

*****IMPORTANT NOTICE*****

-Do **NOT** return to place of purchase- For
customer service and warranty issues
contact our Customer Service Center at:
(866)-985-7877 OR

Email: cservice@welltraveled.net

Customer Service Hours: Mon. – Fri. 9:00 a.m. – 6:00 p.m. (EST)