Ambient Weather WR-336 AM/FM/WB Weather Alert Radio Projection Alarm Clock with Indoor and Wireless Temperature User Manual



Table of Contents

1.	Introduction.....	2
2.	Controls.....	2
3.	Warnings	3
4.	Features	4
5.	Power Sources.....	4
6.	Operation.....	4
6.1	Wireless Remote Sensor Operation.....	4
6.1.1	Temperature Unit of Measure.....	5
6.1.2	Sensor Search.....	5
6.1.3	Best Practices for Wireless Communication	5
6.2	Time and Temperature Operation.....	5
6.3	Radio Operation	6
6.4	Setting Date and Time	6
6.5	Setting Alarm 1 and Alarm 2.....	7
6.6	Radio Band Mode.....	7
6.6.1	AM/FM Radio Tuning.....	8
6.6.2	Preset Channels	8
6.6.3	Weather Band Tuning.....	8
6.6.4	Weather Alert Mode	8
6.6.5	Sleep Mode.....	9
6.7	Projection Operation.....	9
6.8	Projection Focus.....	9
6.9	Backlight Operation	9
6.10	Resetting the WR-336	9
7.	Care and Maintenance.....	9
7.1	General Care and Maintenance	9
8.	Specifications.....	9
9.	Troubleshooting Guide.....	11
10.	Accessories.....	12
11.	Liability Disclaimer.....	12
12.	Warranty Information	12
13.	FCC Statement.....	13
14.	Battery Recycle Statement.....	14

1. Introduction

Thank you for your purchase of the Ambient Weather WR-336 AM/FM/WB Weather Alert Radio Projection Alarm Clock with Indoor and Wireless Temperature. To download the latest full size manual (for easy viewing) and additional troubleshooting tips, please visit:

<http://ambientweather.wikispaces.com/wr336>

2. Controls

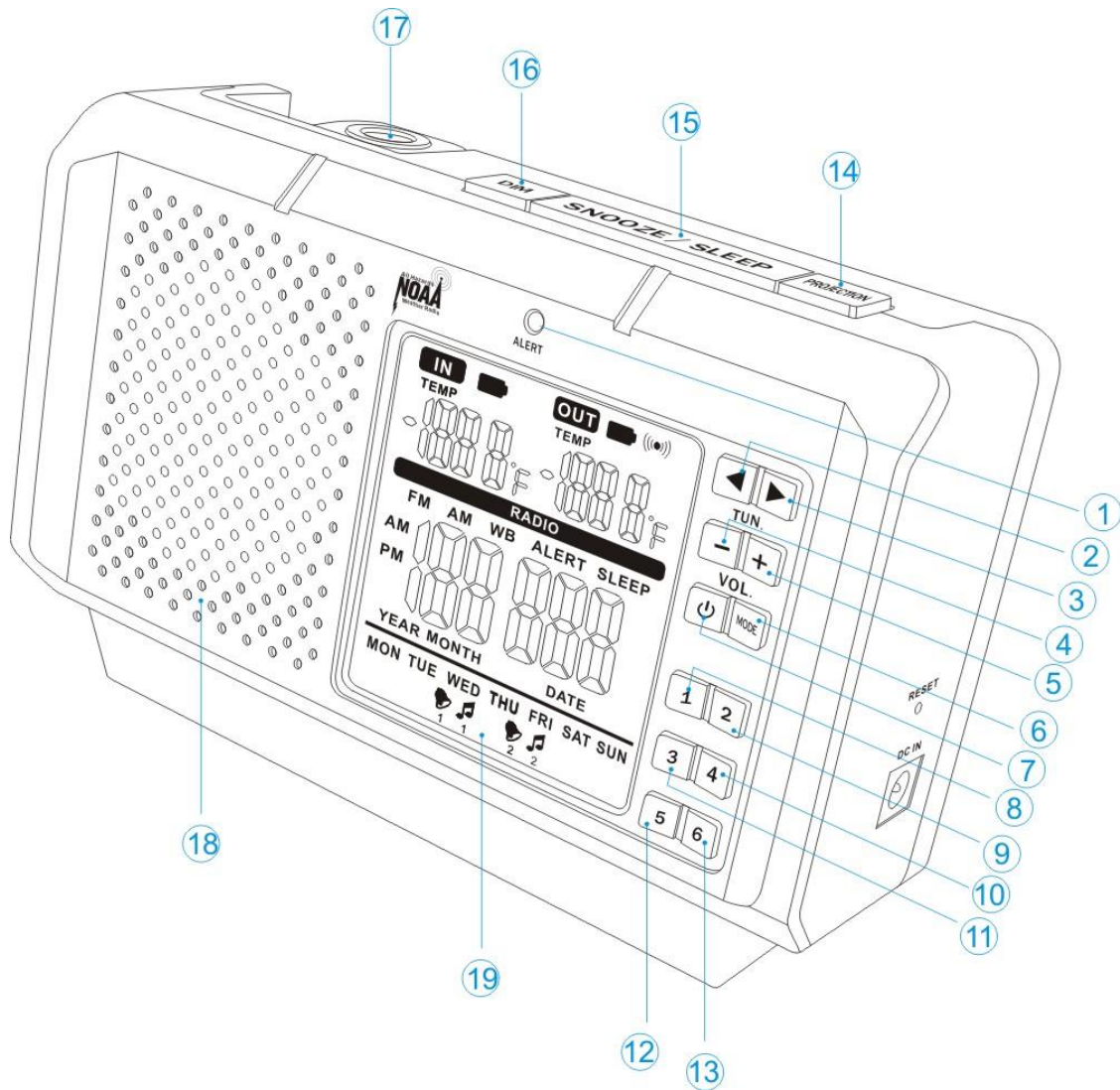

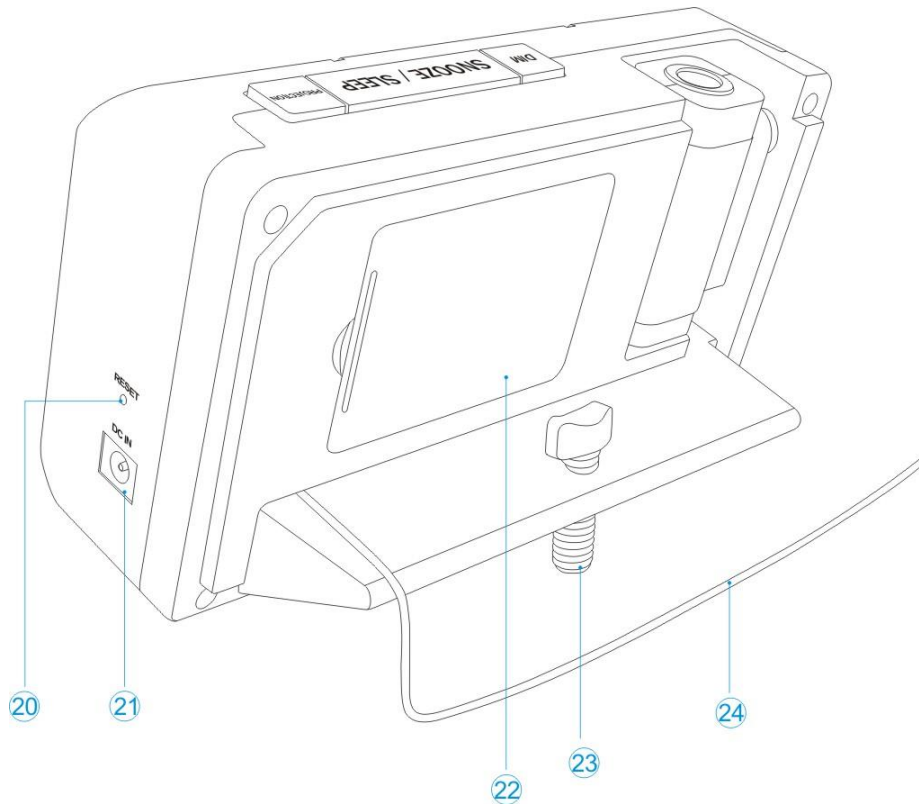

No	Description	No	Description
1	Weather Alert Indicator	16	DIM button
2	Clock/Radio Tune Down button	17	Time Projector
3	Clock/Radio Tune Up button	18	Speaker
4	Volume Down (-) button	19	Alarm Mode
5	Volume Up (+) button	20	RESET Button
6	Radio Mode Select button	21	DC Jack for AC Adapter
7-13	Station Preset buttons 1-5	22	Battery Cover
14	Projection button	23	Angle Adjustment Screw
15	Snooze / Sleep button	24	FM Antenna

Figure 1

3. Warnings

Please read all safety and operating instructions carefully before installation and use, and keep these instructions handy for future reference. Take special note of all warnings listed in these instructions.

Before using this product, please read the following warning and cautions:

1. Read these instructions – All the safety and operating instructions should be read before the WR-336 is operated.
2. Keep these instructions – The safety and operating instructions should be kept for future reference.

3. Heed all warnings – All warnings on the device and in the operating instructions should be adhered to.
4. Follow all instructions – All operation and use instructions should be followed
5. Do not use this item in water – The device should not be used in water; for example, near a bath tub, washbowl, kitchen sink, laundry tub, in a wet basement, or near a swimming pool when plugged into an external power source, such as AC power.
6. Clean only with dry cloth – The device should be cleaned only as recommended by the manufacturer.
7. Only use attachments / accessories recommended by the manufacturer.
8. Refer all servicing to qualified service personnel. Servicing is required when the device has been damaged in any way, such submersion in water, or the unit has been dropped.
9. This device shall not be exposed to dripping or splashing water and that no object filled with liquids such as vases shall be placed on the device.
10. Unplug immediately if liquid has been spilled or any object has fallen into the WR-336.
11. Power Sources – The device should be connected to a power supply
12. only of the type described in the operating instructions or as marked on the device. Do not overload wall outlet.
13. Do not attempt to dismantle, open or repair this product yourself. If a fault occurs, seek advice from Ambient Weather support only.
14. Only operate within specified temperature range (32 °F to 131 °F).
15. Do not store the AA batteries for extend periods of time. They may leak or rupture and damage the WR-336.
16. Never look directly into the time and temperature projector. This can cause temporary blindness.

4. Features

The WR-336 includes the following features:

- AM/FM/WeatherBand radio with Weather Alert
- Six preset buttons for AM and FM
- Clock and Calendar
- Blue backlight
- Projection clock
- Indoor temperature
- Wireless outdoor temperature
- Clock alarm with beep or radio
- Alarm with snooze

5. Power Sources

The WR-336 can be powered from the following sources:

- AC Power (AC adapter included)
- 2 x AA batteries (not included)

6. Operation

6.1 Wireless Remote Sensor Operation



Note: The WR-336 only supports one remote sensor. Make sure the sensor reads channel 1.

1. Place the batteries in the wireless sensor first. Make sure the LCD displays temperature on the wireless sensor. Verify the channel number is 1 (the WR-336 does not support additional

channels).

2. Move the remote thermometer about 5 to 10' away from the radio (if the sensor is too close, it may not be received by the radio).
3. Connect the radio with AC power. The search icon will be displayed in the upper right hand corner of the display console.
4. The wireless sensor will be displayed on the radio in about 1-3 minutes. **Do not touch any buttons** during the search mode, or the radio will exit the search mode.

6.1.1 Temperature Unit of Measure

To change the temperature units of measure, while in time display mode (radio is turned off), press the VOL- button to switch between temperature °F and °C.

6.1.2 Sensor Search

If the wireless sensor communication is lost, the OUT temperature field will be blank. To reacquire the signal, while in time display mode (radio is turned off), press and hold VOL+ button for 3 seconds.

6.1.3 Best Practices for Wireless Communication

 **Note:** To insure proper communication, mount the remote sensor on a vertical surface, such as a wall. **Do not lay the sensor flat.**

Wireless communication is susceptible to interference, distance, walls and metal barriers. We recommend the following best practices for trouble free wireless communication.

1. **Electro-Magnetic Interference (EMI).** Keep the console several feet away from computer monitors and TVs.
2. **Radio Frequency Interference (RFI).** If you have other 433 MHz devices and communication is intermittent, try turning off these other devices for troubleshooting purposes. You may need to relocate the transmitters or receivers to avoid intermittent communication.
3. **Line of Sight Rating.** This device is rated at 300 feet line of sight (no interference, barriers or walls) but typically you will get 100 feet maximum under most real-world installations, which include passing through barriers or walls.
4. **Metal Barriers.** Radio frequency will not pass through metal barriers such as aluminum siding. If you have metal siding, align the remote and console through a window to get a clear line of sight.

The following is a table of reception loss vs. the transmission medium. Each “wall” or obstruction decreases the transmission range by the factor shown below.

Medium	RF Signal Strength Reduction
Glass (untreated)	5-15%
Plastics	10-15%
Wood	10-40%
Brick	10-40%
Concrete	40-80%
Metal	90-100%

6.2 Time and Temperature Operation

While in the clock mode (the radio is turned off), press the **MODE** button to switch the display between Time→Year→Month and Date→Alarm time. If there is no operation for 30 seconds, the clock will return to time display.

6.3 Radio Operation

The WR-336 includes a digital LCD display (Figure 2) with backlighting, with the following push button controls:











- **POWER** . Turns on and off the radio. Transitions from clock display to radio tuner display.
- **MODE**. Switches the radio band between AM, FM, weather band, and weather band alert mode.
- **TUN** : Adjusts the radio frequency up
- **TUN** : Adjusts the radio frequency down
- **VOL+**: Adjusts the radio volume up
- **VOL-**: Adjusts the radio volume down
- **Preset 1,2,3,4,5,6**: Switch to programmed preset channels.







Figure 2

6.4 Setting Date and Time

When first powered up, the time will default to 12:00 AM. In time display mode (radio is turned off):

1. **Set 12Hr/24Hr Mode.** Press and hold the **MODE** button for three seconds to enter the time setting mode. 12 Hr will begin flashing. Press the **TUN**  button to switch between 12 hour and 24 hour time mode. Press the **MODE** button to proceed to the next step.
2. **Set Hour.** Press the **TUN**  or **TUN**  to adjust the hour up or down. Hold the **TUN** button to change rapidly. Press the **MODE** button to proceed to the next step.
3. **Set Minute.** Press the **TUN**  or **TUN**  to adjust the minute up or down. Hold the **TUN** button to change rapidly. Press the **MODE** button to proceed to the next step.
4. **Set Month.** Press the **TUN**  or **TUN**  to adjust the month up or down. Hold the **TUN** button to change rapidly. Press the **MODE** button to proceed to the next step.

5. **Set Day.** Press the **TUN**  or **TUN**  to adjust the day up or down. Hold the **TUN** button to change rapidly. Press the **MODE** button to proceed to the next step.
6. **Set Year.** Press the **TUN**  or **TUN**  to adjust the year up or down. Hold the **TUN** button to change rapidly. Press the **MODE** button to exit the time setting mode (or wait 30 seconds for timeout).

6.5 Setting Alarm 1 and Alarm 2











6.5.1 Setting the Alarm Type, Alarm Time and Day of Week

There are two separate alarm times, which can be set based on a schedule. When the alarms are off,



While in the clock mode (the radio is turned off), press the **MODE** button to switch to Alarm Time 1 or Alarm Time 2.



Time → **Year** → **Month and Date** → **Alarm Time 1** → **Alarm Time 2**

With either Alarm Time 1 or Alarm Time 2 displayed:

1. **Set Alarm Hour.** Press and hold the **MODE** button for three seconds to enter the alarm time setting mode. The alarm hour will begin flashing. Press the **TUN**  or **TUN**  to adjust the hour up or down. Hold the **TUN** button to change rapidly. Press the **MODE** button to proceed to the next step.
2. **Set Alarm Minute.** Press the **TUN**  or **TUN**  to adjust the alarm minute up or down. Hold the **TUN** button to change rapidly. Press the **MODE** button to proceed to the next step.
3. **Set Alarm Week Day.** Press the **TUN**  or **TUN**  to adjust the day of week between today, weekdays (Monday thru Friday), weekends (Saturday and Sunday) and 7 days a week. Press the **MODE** button to proceed to the next step.
4. **Set Alarm Type.** Press the **TUN**  or **TUN**  to switch between the alarm buzzer  and the radio alarm . Press the **MODE** button to exit the time setting mode (or wait 30 seconds for timeout).

6.5.2 Turning On and Off Alarm 1 and Alarm 2

While in the clock mode (the radio is turned off), press the **TUN**  key to turn on and off Alarm 1. Press the **TUN**  key to turn on and off Alarm 2.

When the alarm is turned on, the the alarm buzzer  or the radio alarm  icon will appear.

6.6 Radio Band Mode

Press the **POWER**  button to turn the radio on and transition from the time mode.

The radio will default to **FM** band (or the last radio band since power up). Press the **MODE** button to change to the **AM** band. Press the **MODE** button to change to the Weather Band (**WB**). While displaying the Weather Band, press the **MODE** button again to change to Weather Band Alert mode

(ALERT).

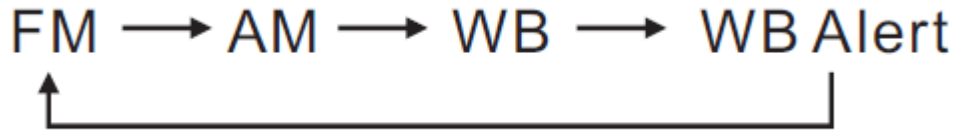





Figure 3

6.6.1 AM/FM Radio Tuning

When the radio is turned on, press the **TUN**  button to increase the frequency and press the **TUN**  button to decrease the frequency.

To tune quickly, press and hold the **TUN** ( or ) button for at least one second. When you let go, the radio will automatically tune to next radio station with sufficient reception.

6.6.2 Preset Channels

There are five preset channels. To set the preset channels, tune to the favorite AM/FM channel(s) and press and hold the preset button (1-6) until the WR-336 beeps.

6.6.3 Weather Band Tuning

There are seven distinct weather channels. The frequencies are 162.400 MHz, 162.425 MHz, 162.450 MHz, 162.475 MHz, 162.500 MHz, 162.525 MHz and 162.550 MHz.

For a complete list of weather radio broadcasting stations, please visit the National Weather Service website:

www.nws.noaa.gov/nwr/indexnw.htm

Our recommendation is to tune to the station with the best reception using the **TUN**  button. You will hear the “voice of the National Weather Service”, and automated voice that provides forecast information, weather statements, watches and warnings.

6.6.4 Weather Alert Mode

When you enter the Weather Alert Mode, the radio will enter standby mode and will be silenced. The radio will remain in standby mode until there is a weather statement, watch or warning. To activate the Weather Alert Mode, tune to your local station as defined in the previous section.

Press the **MODE** button until the **ALERT** symbol is displayed. The **ALERT** symbol will continue to be displayed until there is a weather statement, watch or warning. In the event of an alert, the alert light will flash and the radio will sound (with the voice of the National Weather Service). To disable the alert light, press any button. To disable the alert light but continue in alert mode, press and hold the **MODE** button to two seconds.

To verify you have reception in your area, the National Weather Service (NWS) normally run tests each Wednesday between 10 a.m. and noon local time. Tests may occur at other days and times when there is a threat of severe weather in the listening area or for other reasons.

When a weather alert occurs, the radio will sound and the weather alert light will flash on the front of the ADVENTURER2. Press the power button  to disable the weather alert.

NOTE: If battery power is low, the WR-336 will exit the weather alert mode and enter the time display mode.

NOTE: The weather alert mode consumes a significant amount of power because it is constantly scanning for the emergency 1050 Hz tone from the National Weather Service. We recommend connecting AC power for continuous alert operation.

6.6.5 Sleep Mode

While radio is on, press **SNOOZE/SLEEP** button on the top of the radio to turn on sleep mode. The sleep time or OFF icon will flash. Press **SNOOZE/SLEEP** button to change the sleep duration between 15 minutes, 30 minutes, 60 minutes, 90 minutes, or OFF to turn off the sleep mode.

6.7 Projection Operation

Press the **PROJECTION** button on the top of the radio to project current time. Press the button a second time to reverse the projection 180 degrees. Press the button a third time to turn off the projection.

When the alarm is activated the projection turns on for 2 minutes.

6.8 Projection Focus

Adjust the focus of the projected data by rotating the focus knob on the projector.

6.9 Backlight Operation

Press and hold the **DIM** button for three seconds to turn on the backlight. There are three levels of brightness. Press the **DIM** button to change the backlight brightness.

To turn off the backlight, press and hold the **DIM** button for three seconds to turn off the backlight.

6.10 Resetting the WR-336

If no display is present after powering up the radio, or the radio is locked up, press the reset button on the side of the radio with an open ended paper clip or sharp tool.

7. Care and Maintenance

7.1 General Care and Maintenance

- Do not tamper the internal components of the WR-336.
- Clean your unit with a damp (never wet) cloth. Solvent or detergent should never be used.
- Avoid leaving your unit in direct sunlight or in hot, humid or dusty places.
- Keep your unit away from heating appliances and sources of electrical noise such as fluorescent lamps or motors

8. Specifications

Radio Bands:

AM: 525 KHz to 1710 KHz

FM: 88 MHz to 108 MHz

WeatherBand: 162.400 to 162.550 MHz

Size and Dimensions:

Dimensions: 6.5"L x 4.5"H x 3.0"W

Weight: appx one lb.

Radio Temperature Range:

Working temperature range: 32 to 131 °F (0 to 55 °C)

Storage temperature range: 14 to 140 °F (-10 to 60 °C)

Outdoor Sensor Range (if included):



Outdoor temperature range: non-lithium batteries: -4°F to 140°F (-20°C to 60°C)

Outdoor temperature range: lithium batteries: -40°F to 140°F (-40°C to 60°C)

9. Troubleshooting Guide

If your question is not answered here, you can contact us as follows:



1. Email Support: support@ambientweather.com
2. Live Chat Support: www.ambientweather.com/chat.html (M-F 8am to 4pm Arizona Time)
3. Technical Support: 480-283-1644 (M-F 8am to 4pm Arizona Time)

Problem	Solution
<p>Wireless sensor is not reporting in to console.</p>	<p>If any of the sensor communication is lost, the temperature field will be blank on the screen. To reacquire the signal, press and hold the CHANNEL/+ button for 3 seconds, and the remote search icon  will flash. Once the signal is reacquired, the remote search icon  will turn on, and the current values will be displayed.</p> <p>The maximum line of sight communication range is 300' and 100' under most conditions. Move the sensor assembly closer to the display console.</p> <p>If the sensor assembly is too close (less than 5'), move the sensor assembly away from the display console.</p> <p>Make sure the remote sensor LCD display is working and the transmitter light is flashing once per 60 seconds.</p> <p>Install a fresh set of batteries in the remote thermometer. For cold weather environments, install lithium batteries.</p> <p>Make sure the remote sensors are not transmitting through solid metal (acts as an RF shield), or earth barrier (down a hill).</p> <p>Move the display console around electrical noise generating devices, such as computers, TVs and other wireless transmitters or receivers.</p> <p>Move the remote sensor to a higher location. Move the remote sensor to a closer location.</p>
<p>Indoor and Outdoor Temperature do not agree</p>	<p>Allow up to one hour for the sensors to stabilize due to signal filtering. The indoor and outdoor temperature sensors should agree within 2 °F (the sensor accuracy is ± 1 °F).</p>
<p>Display console contrast is weak</p>	<p>Replace console batteries with a fresh set of batteries.</p>

10. Accessories

The following software and hardware accessories are available for the WR-336 at www.AmbientWeather.com.

The radio supports only one sensor at a time.

Item Number	Image	Description
F007T		Air temperature sensor.
F007TP		Temperature sensor with probe.
F007TP		Floating pool and spa thermometer.

11. Liability Disclaimer

- Please help in the preservation of the environment and return used batteries to an authorized depot.
- The electrical and electronic wastes contain hazardous substances. Disposal of electronic waste in wild country and/or in unauthorized grounds strongly damages the environment.
- Reading the “User manual” is highly recommended.
- The specifications of this product may change without prior notice.
- This product is not a toy. Keep out of the reach of children.
- No part of this manual may be reproduced without written authorization of the manufacturer. Ambient, LLC WILL NOT ASSUME LIABILITY FOR INCIDENTAL, CONSEQUENTIAL, PUNITIVE, OR OTHER SIMILAR DAMAGES ASSOCIATED WITH THE OPERATION OR MALFUNCTION OF THIS PRODUCT.

12. Warranty Information

Ambient, LLC provides a 1-year limited warranty on this product against manufacturing defects in materials and workmanship.

This limited warranty begins on the original date of purchase, is valid only on products purchased and only to the original purchaser of this product. To receive warranty service, the purchaser must contact Ambient, LLC for problem determination and service procedures.

Warranty service can only be performed by Ambient, LLC. The original dated bill of sale must be presented upon request as proof of purchase to Ambient, LLC.

Your Ambient, LLC warranty covers all defects in material and workmanship with the following specified exceptions: (1) damage caused by accident, unreasonable use or neglect (lack of reasonable and necessary maintenance); (2) damage resulting from failure to follow instructions contained in your owner's manual; (3) damage resulting from the performance of repairs or alterations by someone other than an authorized Ambient, LLC authorized service center; (4) applications and uses that this product was not intended (5) the products inability to receive a radio signal due to any source of interference, metal obstructions or other reception issues.

This warranty covers only actual defects within the product itself, and does not cover the cost of installation or removal from a fixed installation, normal set-up or adjustments, claims based on misrepresentation by the seller or performance variations resulting from installation-related circumstances.

13. FCC Statement

This device complies with Part 15 of the FCC Rules. Operation is subject to the following two conditions:

- (1) this device may not cause harmful interference, and
- (2) this device must accept any interference received, including interference that may cause undesired operation.

NOTE: This equipment has been tested and found to comply with the limits for a Class B digital device, pursuant to Part 15 of the FCC Rules. These limits are designed to provide reasonable protection against harmful interference in a residential installation. This equipment generates, uses and can radiate radio frequency energy and, if not installed and used in accordance with the instructions, may cause harmful interference to radio communications. However, there is no guarantee that interference will not occur in a particular installation. If this equipment does cause harmful interference to radio or television reception, which can be determined by turning the equipment off and on, the user is encouraged to try to correct the interference by one or more of the following measures:

- Reorient or relocate the receiving antenna.
- Increase the separation between the equipment and receiver.
- Connect the equipment into an outlet on a circuit different from that to which the receiver is connected.
- Consult the dealer or an experienced radio/TV technician for help



14. Battery Recycle Statement



Recycle Rechargeable Batteries

Recycle your old batteries at one of the many collection sites in the U.S. and Canada. To find the site nearest you, visit www.call2recycle.org or call toll-free 1-877-2-RECYCLE.